

Patch cable - VS-06-2X2X26C7/7-67/67/ 1,0 - 1654002

Please be informed that the data shown in this PDF Document is generated from our Online Catalog. Please find the complete data in the user's documentation. Our General Terms of Use for Downloads are valid (<http://download.phoenixcontact.com>)



Assembled FireWire cable, shielded, color: RAL 5021 (water blue), PUR outer sheath, FireWire/IP67 on FireWire/IP67, length: 1 m



Key commercial data

Packing unit	1 pc
GTIN	 4 017918 970338
Weight per Piece (excluding packing)	124.4 GRM
Custom tariff number	85444290
Country of origin	Germany

Technical data

Mechanical characteristics

Number of positions	6
Shielded	Yes
Insertion/withdrawal cycles	≥ 1000
Cable diameter	6.70 mm
Cable structure	2x2xAWG26/7 + 2xAWG20/19; S/FTP
Length of cable	1 m

Ambient conditions

Ambient temperature (operation)	-20 °C ... 60 °C (cable, fixed installation)
	0 °C ... 50 °C (cable, flexible installation)
	(Plug / socket)
Degree of protection	IP67

Material data

Patch cable - VS-06-2X2X26C7/7-67/67/ 1,0 - 1654002

Technical data

Material data

Housing material	PA
Sealing material	FPM
Outer sheath, material	PUR
External sheath, color	water blue RAL 5021

Electrical characteristics

Rated voltage (III/3)	125 V
Rated current	1 A
Transmission characteristics (category)	FireWire (400 Mbps)

Line characteristics

Cable type	FireWire
Cable structure	2x2xAWG26/7 + 2xAWG20/19; S/FTP
Conductor cross section	2x 2x 0.14 mm ² (signal line) 2x 0.5 mm ² (Power supply)
AWG signal line	26
Conductor structure signal line	7x 0.15 mm
AWG power supply	20
Conductor structure, voltage supply	19x 0.20 mm
Core diameter including insulation	≤ 1.05 mm (signal line) nom. 1.4 mm (Power supply)
External cable diameter	6.7 mm
Wire colors	White-blue, white-orange, white, black
External sheath, color	water blue RAL 5021
Insulation resistance	5 GΩ*km
Conductor resistance	150 Ω/km
Transmission characteristics (category)	CAT7, for USB 2.0 (480 Mbps)
Working capacitance	42 pF (per meter)
Wave impedance	100 Ω ±5 % (at 100 MHz)
Signal speed	0.72 c
Signal runtime	4.6 ns/m
Shield attenuation	60 dB (Up to 1000 MHz)
Interference suppression	90 dB (Up to 1000 MHz)
Coupling resistance	5.00 mΩ/m (At 10 MHz)
Nominal voltage, cable	≤ 125 V
Test voltage, cable	1000 V
Twisted pairs	2 cores to the pair
Type of pair shielding	Aluminum-lined polyester foil

Patch cable - VS-06-2X2X26C7/7-67/67/ 1,0 - 1654002

Technical data

Line characteristics

Overall twist	Two pairs and two power supply wires to the core
Shielding	Tinned copper braided shield
Outer sheath, material	PUR
Material conductor insulation	Cell PE (signal line)
	PVC (Power supply)
Conductor material	Bare Cu litz wires
Cable weight	59 kg/km
Minimum bending radius, fixed installation	5 x D
Minimum bending radius, flexible installation	5 x D
Tensile strength short-term/long-term	≤ 30 N
Special properties	Free of substances which would hinder coating with paint or varnish
Flame resistance	complying with IEC 60332-2-2
Resistance to oil	according to EN 60811-2-1
Other resistance	Microbe resistance as per DIN VDE 0282
	Hydrolysis resistance as per DIN 53504
Ambient temperature (operation)	-40 °C ... 70 °C (cable, fixed installation)
	-10 °C ... 50 °C (cable, flexible installation)

Classifications

eCl@ss

eCl@ss 4.0	27060306
eCl@ss 4.1	27060306
eCl@ss 5.0	27061801
eCl@ss 5.1	27061801
eCl@ss 6.0	27061801
eCl@ss 7.0	27061801
eCl@ss 8.0	27061801

ETIM

ETIM 2.0	EC000830
ETIM 3.0	EC001855
ETIM 4.0	EC001855
ETIM 5.0	EC001855

UNSPSC

UNSPSC 6.01	30211923
UNSPSC 7.0901	39121522

Patch cable - VS-06-2X2X26C7/7-67/67/ 1,0 - 1654002

Classifications

UNSPSC

UNSPSC 11	39121522
UNSPSC 12.01	39121522
UNSPSC 13.2	39121522

Drawings

Dimensioned drawing

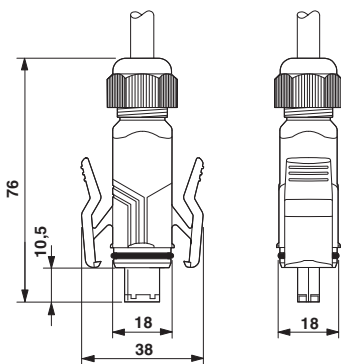

FireWire connector, IP67

Dimensioned drawing

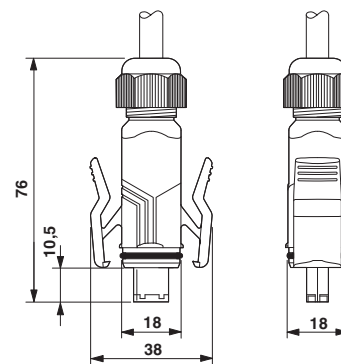

FireWire connector, IP67

Circuit diagram

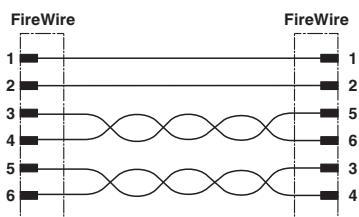

Schematic diagram

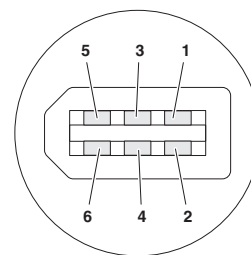

Pin assignment plug FireWire

Patch cable - VS-06-2X2X26C7/7-67/67/ 1,0 - 1654002

Schematic diagram

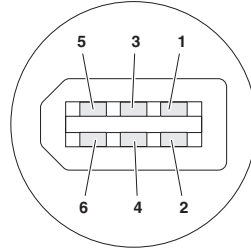

Pin assignment plug FireWire