

## 470MHz INPUT MIXER AND 455kHz FM IF DEMODULATOR IC

### ■ GENERAL DESCRIPTION

The **NJM2592** is a wide-operating voltage, low-current FM IF demodulator IC with 455kHz(standard) IF frequency. It includes an oscillator, mixer, limiting amplifier, quadrature detector, active filter, and FSK comparator.

The **NJM2592** also has a RSSI circuit and RSSI comparator for carrier sense.

### ■ PACKAGE OUTLINE

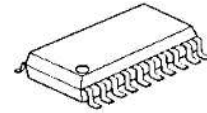

NJM2592V

### ■ FEATURES

- Wide Operating Voltage                    1.8V to 9.0V
- Low Operating Current                    2.2mA type. at  $V^+ = 2.0V$ , external local oscillator input
- Maximum Mixer Input Signal
  - Frequency                                    470MHz (reference value)
  - Level    0dBm
- Mixer Input Resistance                    50Ω
- IF Frequency                                455kHz (standard)
- Conventional Quadrature Detector
  - External Phase-shifting Capacitor
  - External Discriminator or LC Resonant Circuit
- RSSI Comparator with Open-Collector Output
- Quick Charge/Discharge Circuit for FSK Reference Voltage
- Bipolar Technology
- Package Outline                            SSOP20

### ■ BLOCK DIAGRAM

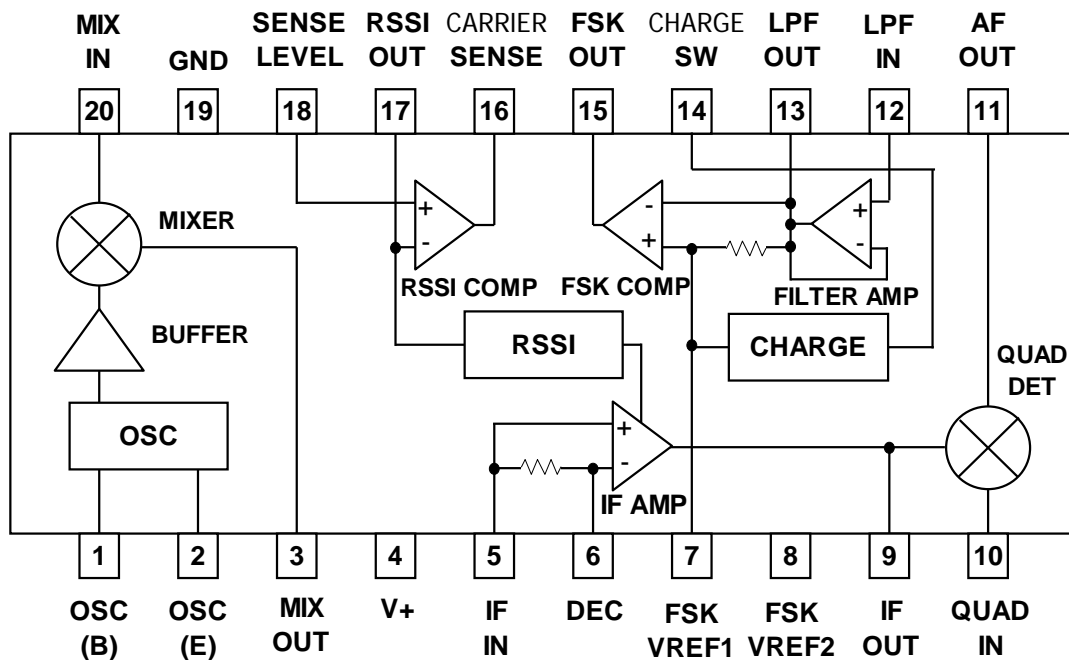

# NJM2592

## ■ ABSOLUTE MAXIMUM RATINGS

(Ta=25°C)

PARAMETER	SYMBOL	RATINGS	UNIT
Supply Voltage	V <sup>+</sup>	10.0	V
Power Dissipation	P <sub>d</sub>	300	mW
Mixer Input Signal Level	V <sub>mixMAX</sub>	0	dBm
Operating Temperature	T <sub>opr</sub>	- 40 to +85	°C
Storage Temperature	T <sub>stg</sub>	- 40 to +125	°C

## ■ RECOMMENDED OPERATING CONDITION

(Ta=25°C)

PARAMETER	SYMBOL	TEST CONDITIONS	MIN.	TYP.	MAX.	UNIT
Supply Voltage	V <sup>+</sup>		1.8	2.5	9.0	V

## ■ ELECTRICAL CHARACTERISTICS

(Ta=25°C, V<sup>+</sup>=2.0V, f<sub>mix</sub>=430MHz, f<sub>lo</sub>=429.545MHz, f<sub>if</sub>=455kHz, f<sub>mod</sub>=600Hz, f<sub>dev</sub>=±4kHz, unless otherwise noted)

PARAMETER	SYMBOL	TEST CONDITIONS	MIN.	TYP.	MAX.	UNIT
Current Consumption	I <sub>ccq</sub>	No signal	1.8	2.2	2.8	mA
Mixer Conversion Gain	G <sub>mix</sub>	V <sub>inMIX</sub> =60dBuVEMF, Measured at Pin3, without IF filter, terminated with 2kΩ	16	20	24	dB
Mixer 3rd Order Intercept	IP3		-	95	-	dBuV
Mixer Input Resistance	R <sub>inM</sub>		-	(50)	-	Ω
Mixer Input Capacitance	C <sub>inM</sub>		-	(2.0)	-	pF
Mixer Output Resistance	R <sub>oM</sub>		-	2.0	-	kΩ
Signal to Noise Ratio 1	S/N1	Mixer input V <sub>inMIX</sub> =60dBuVEMF	-	60	-	dB
Signal to Noise Ratio 2	S/N2	IF input V <sub>inIF</sub> =60dBuVEMF	-	60	-	dB
Signal to Noise Ratio 3	S/N3	IF input V <sub>inIF</sub> =25dBuVEMF	-	30	-	dB
-3dB Limiting Sensitivity	V <sub>in(lim)</sub>	IF input	-	22	-	dBuVEMF
AM Rejection Ratio	AMR	IF input, AM=30% V <sub>inIF</sub> =60dBuVEMF	-	50	-	dB
IF Amplifier Input Resistance	R <sub>inIF</sub>		-	2.0	-	kΩ
RSSI Output Voltage	V <sub>rssi</sub>	IF input V <sub>inIF</sub> =40dBuVEMF	(0.3)	0.45	(0.65)	V

The values shown in parenthesis are reference values.

PARAMETER	SYMBOL	TEST CONDITIONS	MIN.	TYP.	MAX.	UNIT
Demodulated Output Level	Vod	IF input VinIF =60dBuVEMF	75	85	95	mVrms
Duty Ratio of Wave Shaped Output	DR	IF Input VinIF=60dBuVEMF	40	50	60	%
Quick Charge/Discharge Current	Ich	FSK REF=GND LPFOUT=0.4V	35	65	110	uA
High Level Leak Current of CARRIER SENSE Terminal	IcryH	V <sub>CARRIER SENSE</sub> =V <sup>+</sup>	-	(0.0)	-	uA
Low Level Voltage of CARRIER SENSE Terminal	VcryL	I <sub>CARRIER SENSE</sub> =100uA	-	0.1	0.4	V
Bias Current of SENSE LEVEL Terminal	Ilevel	V <sub>CARRIER SENSE</sub> =0.8V	-	(0.0)	-	uA
High Level Leak Current of FSK OUT Terminal	IfskH	V <sub>FSK OUT</sub> =V <sup>+</sup>	-	(0.0)	-	uA
Low Level Voltage of FSK OUT Terminal	VfskL	I <sub>FSK OUT</sub> =100uA	-	0.1	0.4	dB

The values shown in parenthesis are reference values.

## ■ TEST CIRCUIT

This test circuit allows the measurement of all parameters described in "ELECTRICAL CHARACTERISTICS". This test circuit includes some electrical switches that should be in the suitable position for the measurement of each parameter.

### ● Circuit diagram

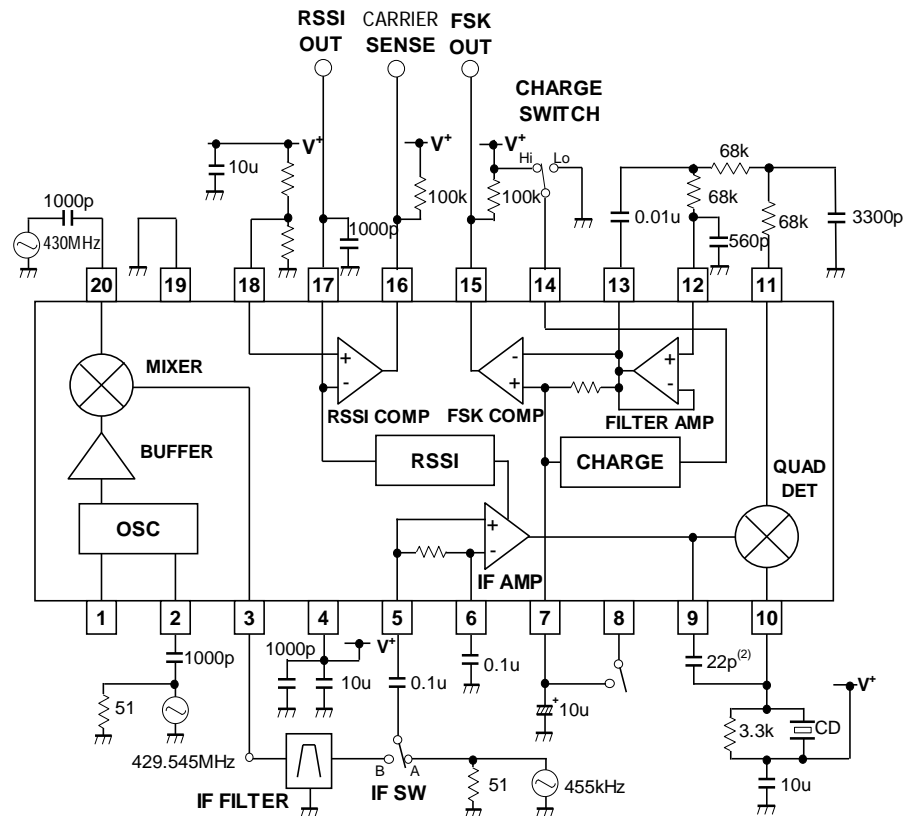

### ● External components

- C D : Ceramic Discriminator, 455kHz
- IF FILTER : Ceramic Filter, 455kHz

### ● Measurement condition

"Condition 1" is the condition for the case of IF input :

- IF SW : in the A position.
- IF IN input signal : input frequency( $f_{if}$ ) = 455kHz, input level( $V_{inIF}$ ) = 60dBuVEMF, modulation frequency( $f_{mod}$ ) = 600Hz, deviation  $f_{dev} = \pm 4$ kHz

"Condition 2" is the condition for the case of Mixer Input :

- IF SW : in the B position
- MIX IN input signal: input frequency( $f_{mix}$ ) = 430MHz, input level( $V_{inMIX}$ ) = 60dBuVEMF, modulation frequency( $f_{mod}$ ) = 600Hz, deviation  $f_{dev} = \pm 4$ kHz
- OSC(E) input signal: input frequency( $f_{osc}$ ) = 429.545MHz, input level( $V_{inOSC}$ ) = 105dBuVEMF

■ **TERMINAL FUNCTION** (Ta=25°C, V+=2.0V)

Pin No.	SYMBOL	EQUIVALENT CIRCUIT	VOLTAGE	FUNCTION
1	OSC (B)		-	<b>Base / Emitter Terminal</b> Colpitts - type oscillator is formed with an external oscillator element of crystal unit or SAW resonator. Output of an external oscillator circuit can also input to pin1 or pin2.
2	OSC (E)		-	
3	MIX OUT		1.1V	<b>Mixer Output</b> An external 455kHz ceramic filter is connected. The typical output impedance is 2kΩ.
4	V+		-	<b>Supply Voltage</b>
5	IF IN		1.94V	<b>IF Limiter Amplifier Input</b> This is an input to the IF amplifier after passing through 455kHz ceramic filter. The typical input impedance is 2kΩ.
6	DEC		1.94V	<b>IF Decoupling</b> An external decoupling capacitor is connected to enhance stability.
7	FSK VREF1		0.55V	<b>FSK Reference Input</b> This pin is an input of reference voltage for FSK comparator. An external capacitor is connected to create an average DC level of FM demodulated signal. The choice of this capacitor is dependent on the speed of data signal. A quick charge/discharge circuit offers the voltage of pin 7 comes the same voltage of pin 11 quickly.

# NJM2592

Pin No.	SYMBOL	EQUIVALENT CIRCUIT	VOLTAGE	FUNCTION
8	FSK VREF2		0.55V	<b>FSK Reference Voltage Output</b> This pin usually keeps open. This fixed output voltage may be available for the FSK reference voltage of wave shaping comparator by connecting to pin7. This usage is effective in shaping the data signal with continuous bits of the same polarity, and discussed in another document related to applications information.
9	IF OUT		1.19V	<b>IF Output</b> An external phase - shifting capacitor is connected between pin9 and pin10.
10	QUAD IN		1.99V	<b>Quadrature Detector Input</b> An external phase - shifting coil or ceramic discriminator is connected.
11	AF OUT		0.55V	<b>FM Demodulated Signal Output</b> An external 3rd order multiple feed - back filter (RC filter) is connected between pin11 and pin13.

Pin No.	SYMBOL	EQUIVALENT CIRCUIT	VOLTAGE	FUNCTION
12	LPF IN		0.55V	<b>Low Pass Filter Input</b> An external RC components forms a band pass filter between pin12 and pin13. This terminal is biased from pin 11 through an external RC filter.
13	LPF OUT		0.55V	<b>Low Pass Filter Output</b>
14	CHARGE SW		--	<b>Quick Charge / Discharge Control</b> The power supply output voltage to pin 14 sets up the quick charge / discharge circuit. Hi : ON Low : OFF Instead of V+, another power source can also be used within the limit of the rated supply voltage.
15	FSK OUT		--	<b>FSK Output</b> The FSK comparator is a wave shaping circuit. A Filter Amplifier output signal is inverted and wave shaped. Instead of V+, another power source can also be used within the limit of the rated supply voltage.
16	CARRIER SENSE		--	<b>Carrier Sense Output</b> This pin outputs the result of RSSI comparator by comparing RSSI output level with an external input level to pin 18.

Pin No.	SYMBOL	EQUIVALENT CIRCUIT	VOLTAGE	FUNCTION
17	RSSI OUT		0.05V	<b>Received Signal Strength Indicator Output</b> Pin 11 outputs DC level proportional to the log of input signal level to pin 20.
18	SENSE LEVEL		--	<b>Sense Level Input</b> External reference voltage of RSSI comparator
19	GND		--	<b>Ground</b>
20	MIX IN		0.27V	<b>Mixer Input</b> The mixer is designed to work up to 470MHz with the typical input impedance of $R_{inM} = 50\Omega$ and $C_{inM} = 2pF$ (at 430MHz).

**Note :**

- ESD protection diodes exist between each of the following pins and  $V^+$ .  
Pin 1,2,3,5,6,7,8,9,10,11,12,13,17,18,20
- ESD protection diodes also exist between each of the following pins and ground.  
Pin 1,2,3,5,6,7,8,9,10,11,12,13,14,15,16,17,18



## APPLICATION CIRCUIT

### External Local Oscillator Signal Input

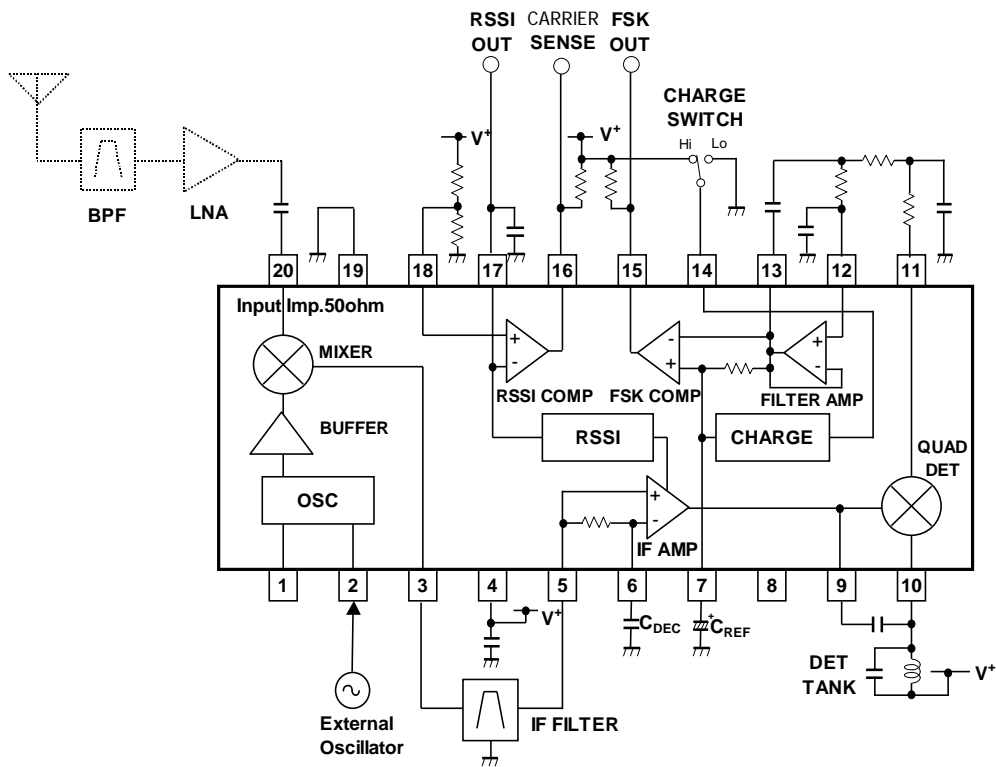

### Local Oscillator with External Crystal and LC Resonant Elements

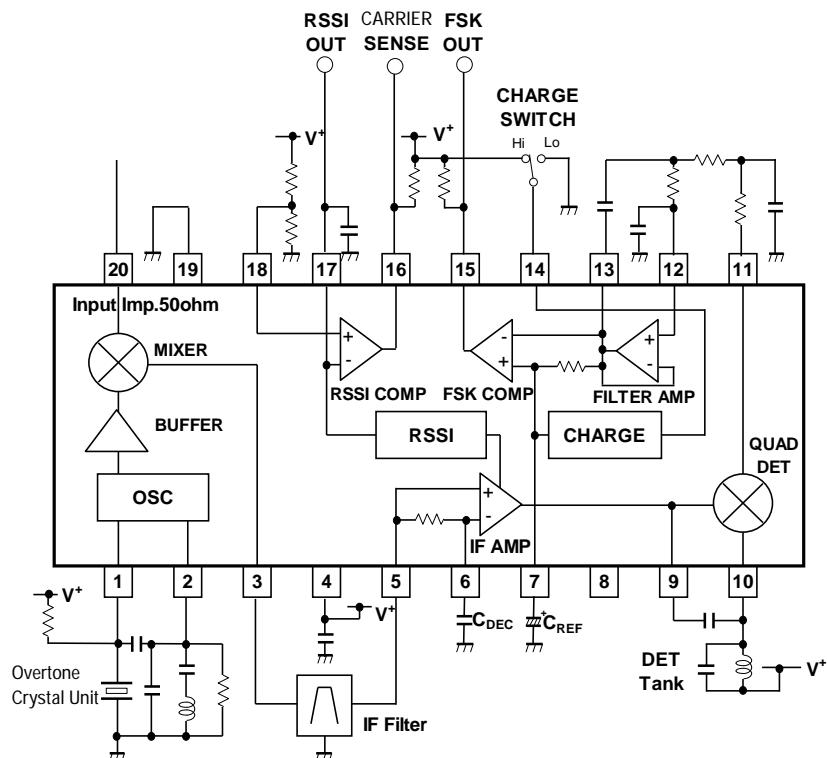

## ■ EVALUATION PC BOARD

The evaluation board is useful for your design and to have more understanding of the usage and performance of this device. This circuit is the same as TEST CIRCUIT. Note that this board is not prepared to show the recommendation of pattern and parts layout.

### ● Circuit Diagram

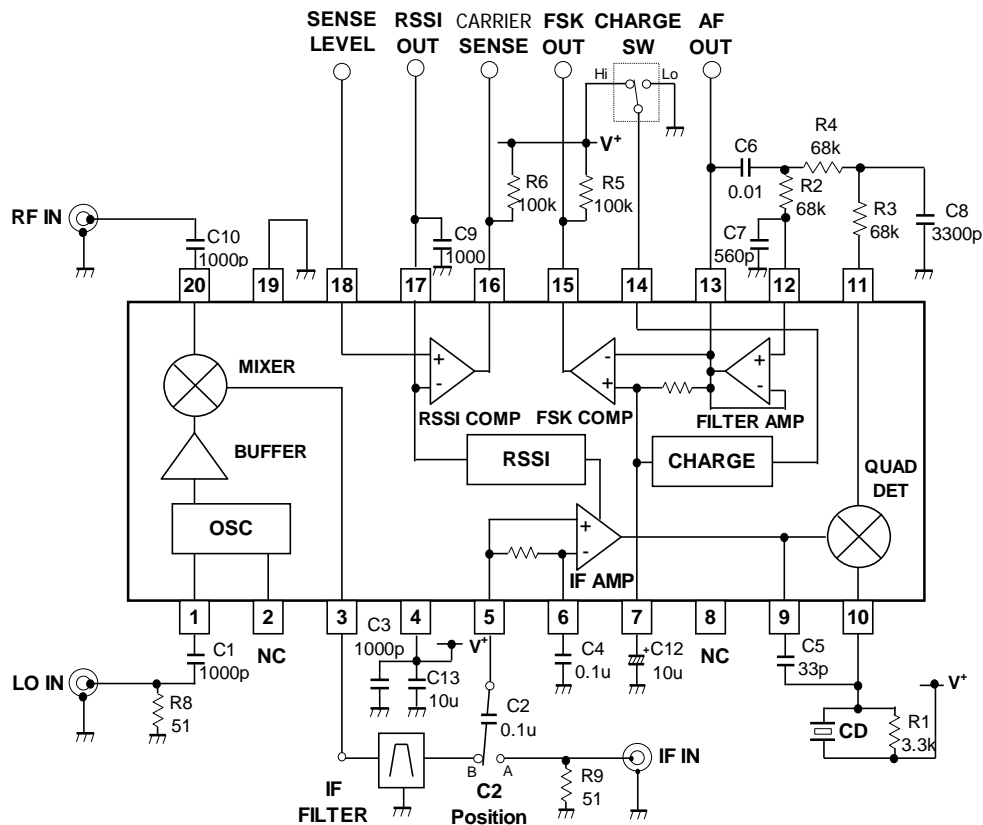

### Note:

1. This board is designed for mixer-input type and C2 is factory-configured as follows:  
C2 : in the B position  
For the case of IF-input type, the position of C2 is necessary to change as follows:  
C2 : in the A position  
The actual position of C2 is shown in the next page.
2. External components  
CD : Ceramic Discriminator, 455kHz  
IF FILTER : Ceramic Filter, 455kHz

● Circuit Side View

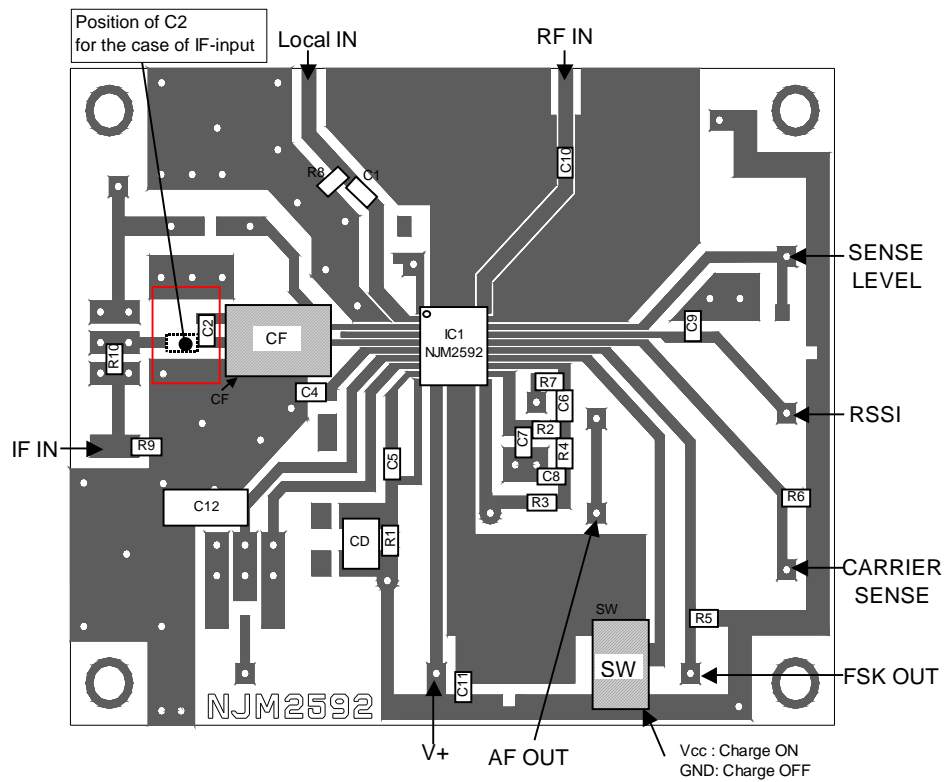

● Ground Side View

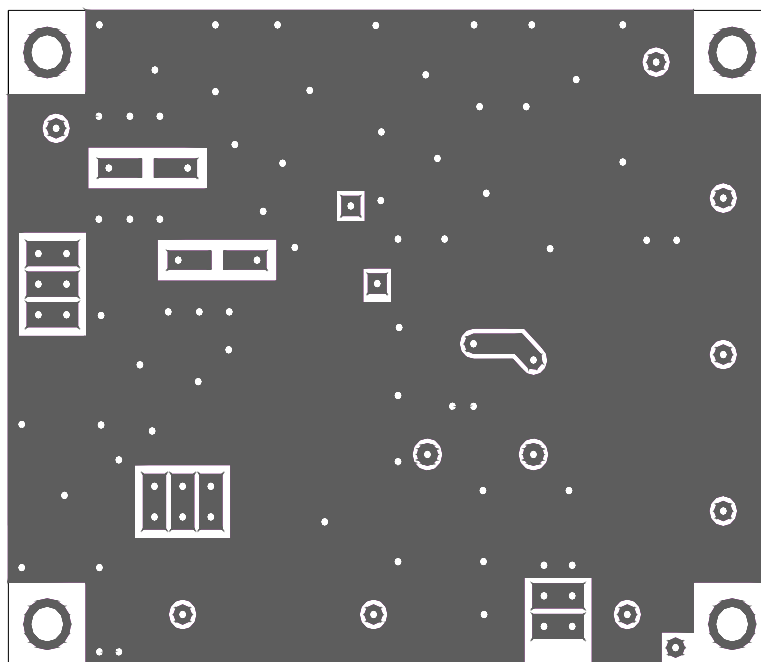

**Note:**

1. External Components

- C1, C3, C9, C10=1000pF    C2, C4=0.1uF    C5=33pF    C6=0.01uF    C7=560p    C8=3300pF  
 C11=0.47uF    C12, C13=10uF  
 R1=3.3kΩ    R2, R3, R4=68kΩ    R5, R6=100kΩ    R7, R10=0Ω    R8, R9=51Ω  
 CF : Ceramic Filter, 455kHz  
 CD : Ceramic Discriminator, 455kHz

## ■ TYPICAL CHARACTERISTICS ( Ta=25°C, V+=2.0V, unless otherwise noted )

Current Consumption versus Supply Voltage

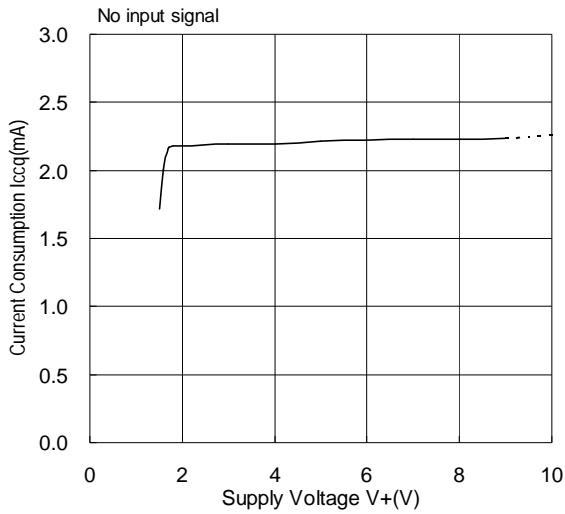

Mixer Conversion Gain versus Supply Voltage

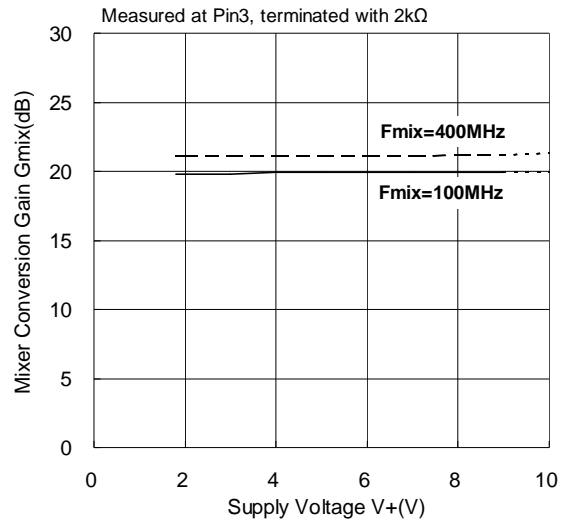

Demodulated Output versus Supply Voltage

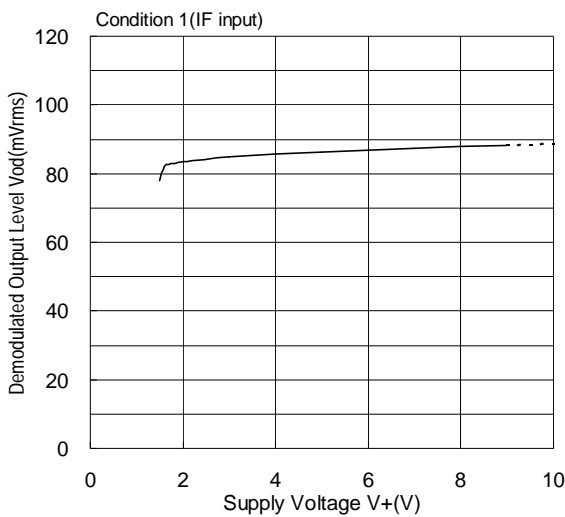

FSK Duty Ratio versus Supply Voltage

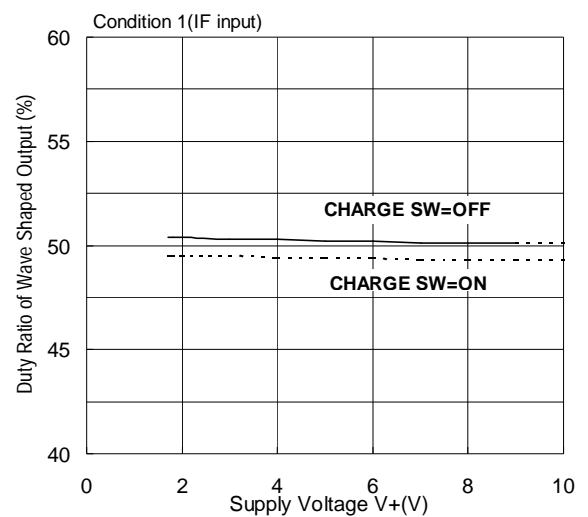

S/N versus Supply Voltage-Mixer Input-

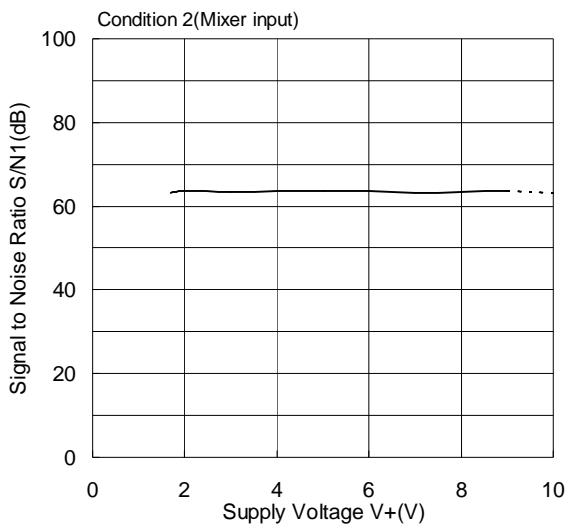

-3dB Limiting Sensitivity versus Supply Voltage

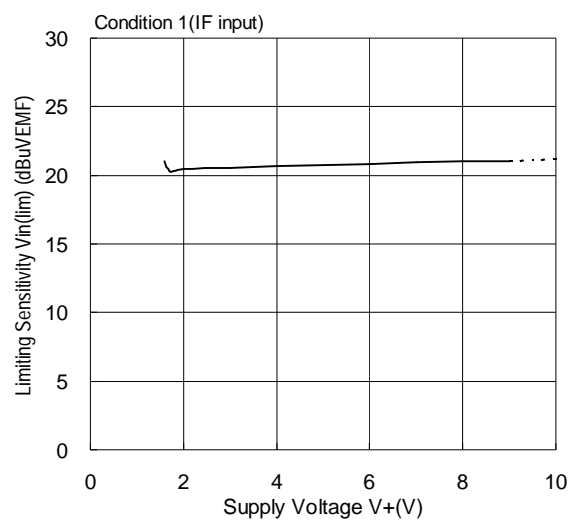

**Mixer Conversion Gain versus Frequency**

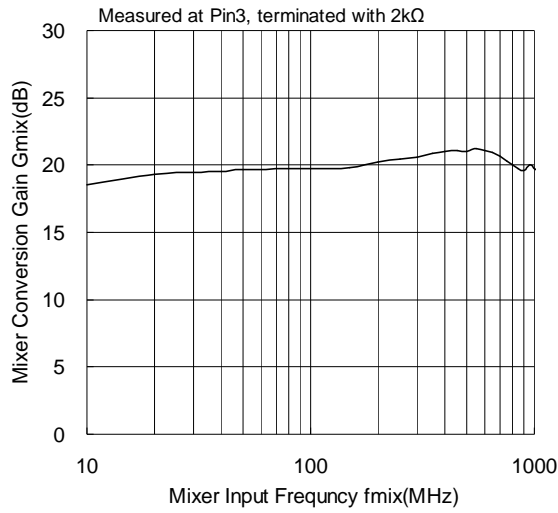

**Mixer Input Level Characteristics**

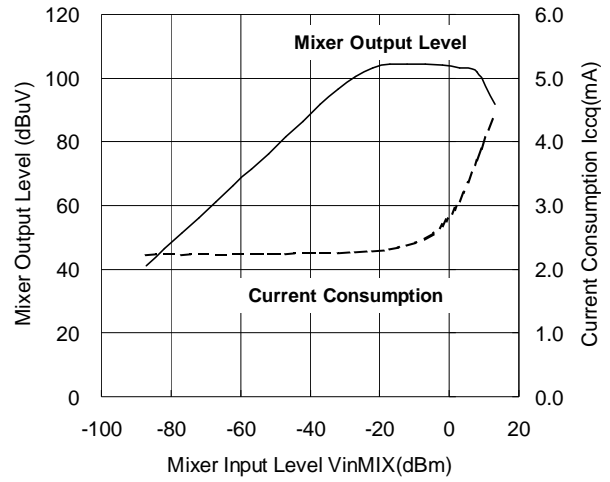

**Mixer Conversion Gain versus OSC Input**

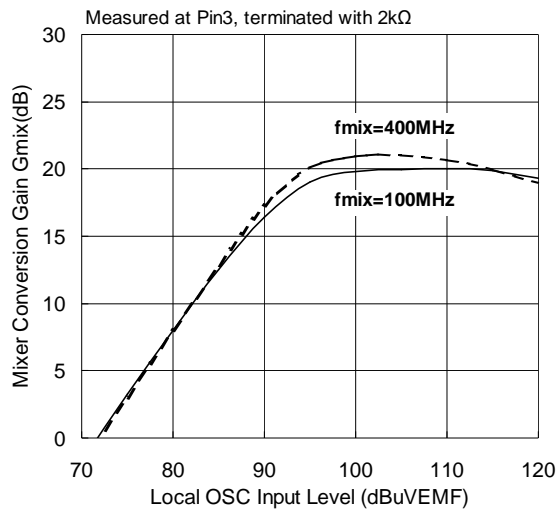

**AF Output versus Frequency:S-Curve**

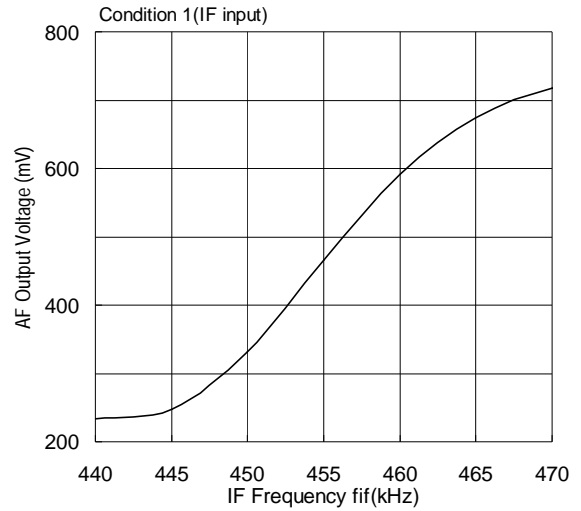

**IF Detuning Characteristics**

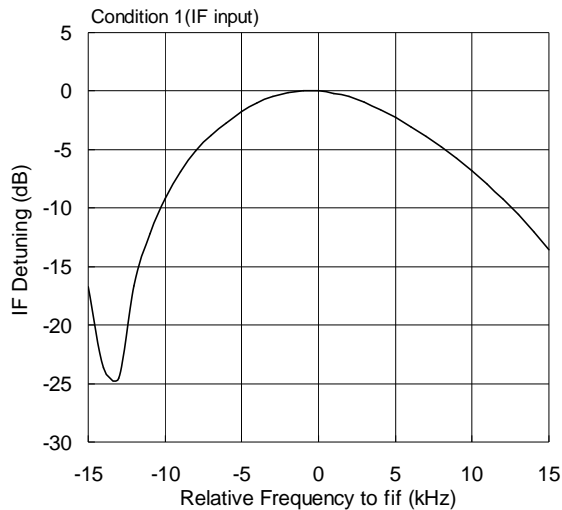

**Carrier Sense Characteristics**

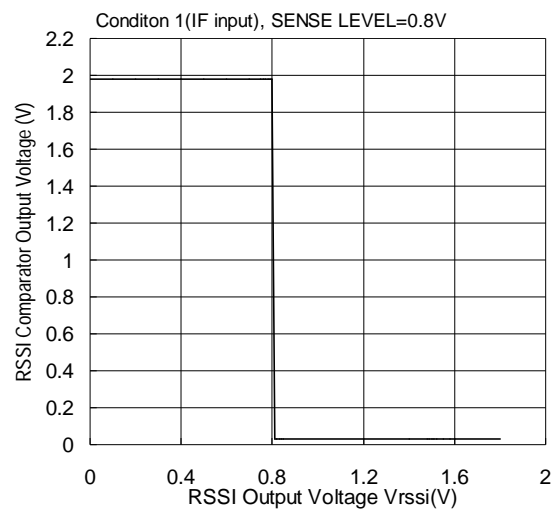

**S+N,N,AMR versus Mixer Input**

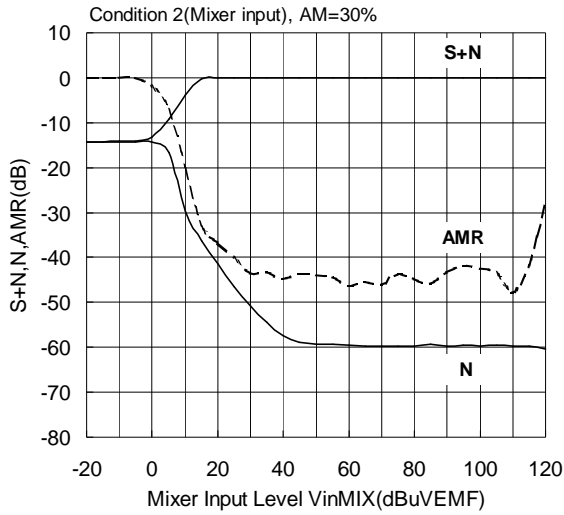

**S+N,N,AMR versus IF Input**

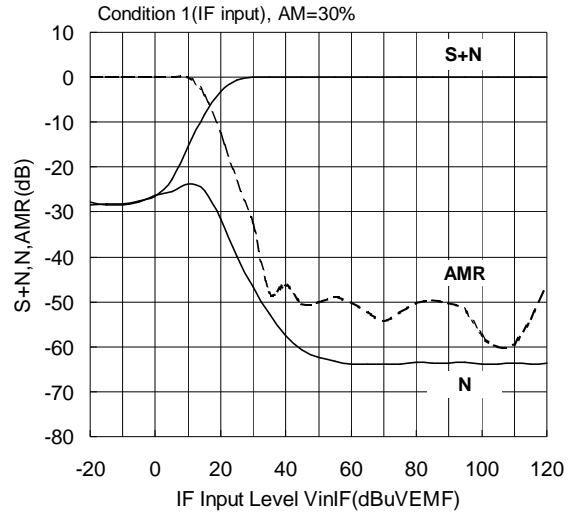

**RSSI Output versus Mixer Input**

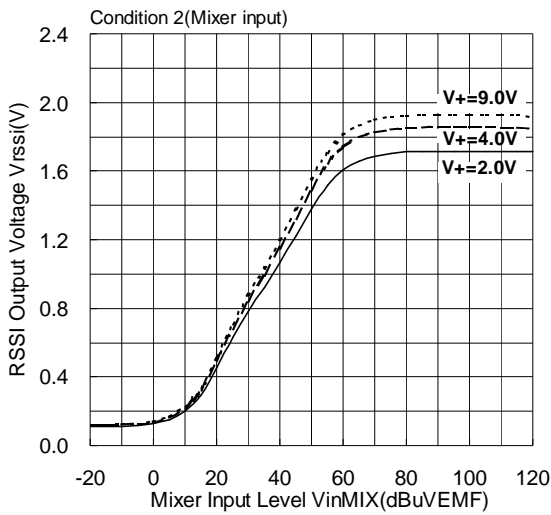

**RSSI Output versus IF Input**

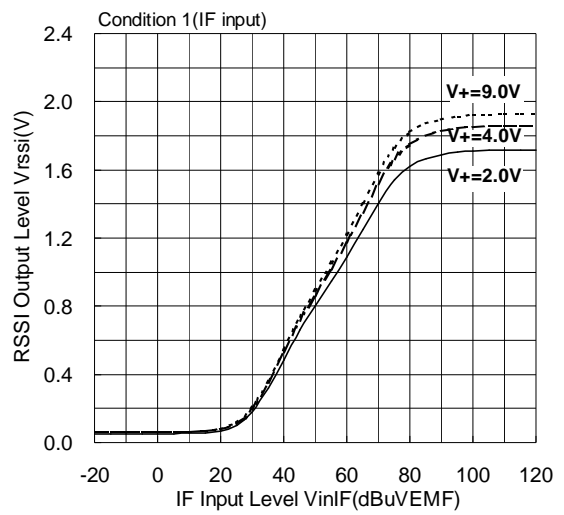

**Quick Charge/Discharge Current versus FSK Reference Input Voltage**

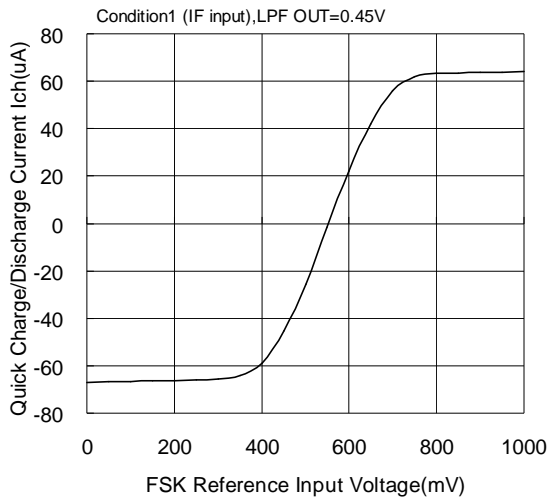

**Current Consumption versus Temperature**

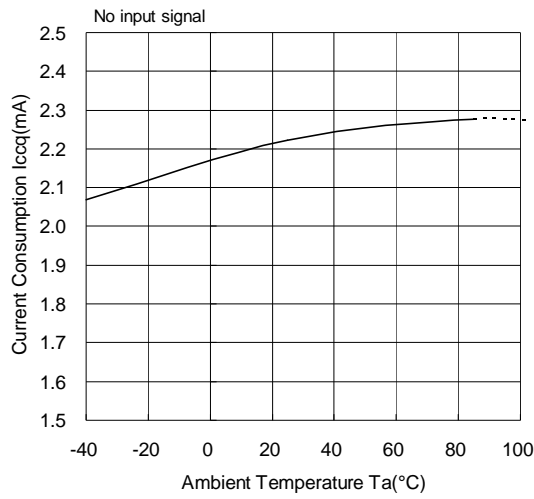

**Mixer Conversion Gain versus Temperature**

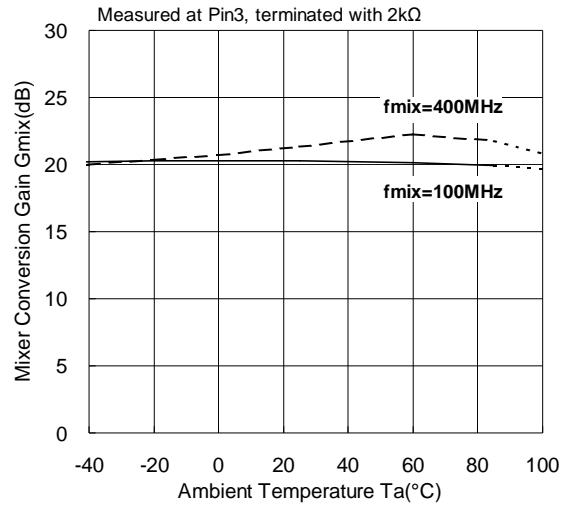

**Demodulated Output Level versus Temperature**

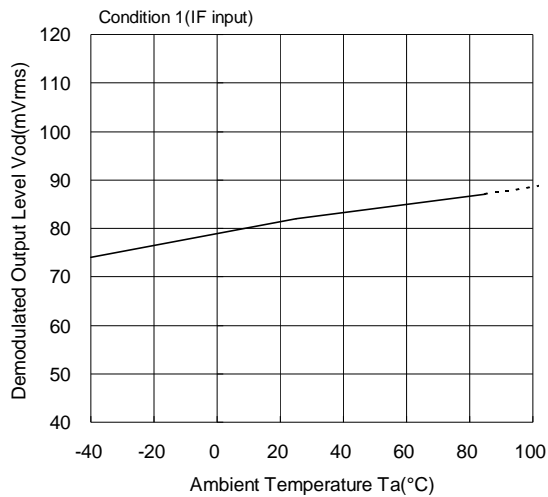

**FSK Duty Ratio versus Temperature**

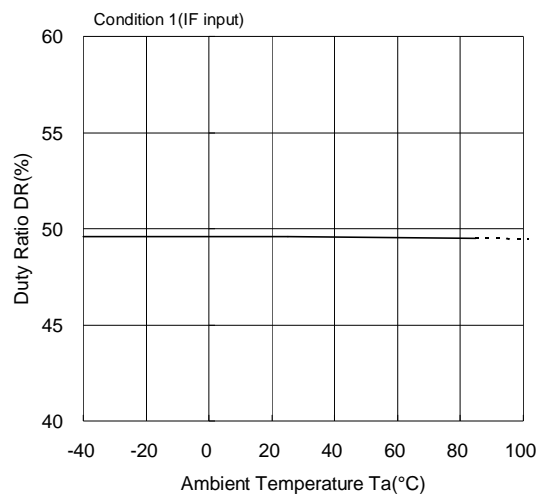

**S/N versus Temperature**

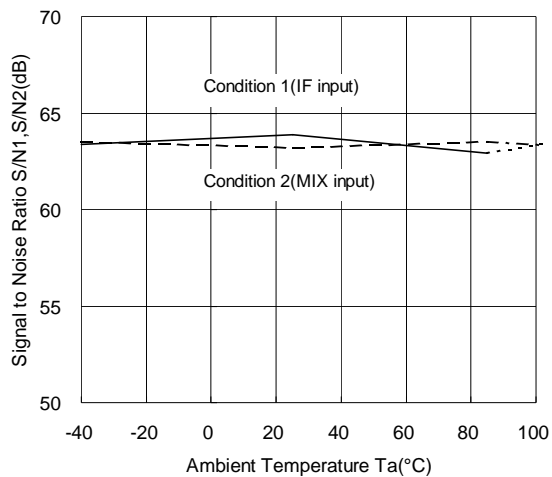

**-3dB Limiting Sensitivity versus Temperature**

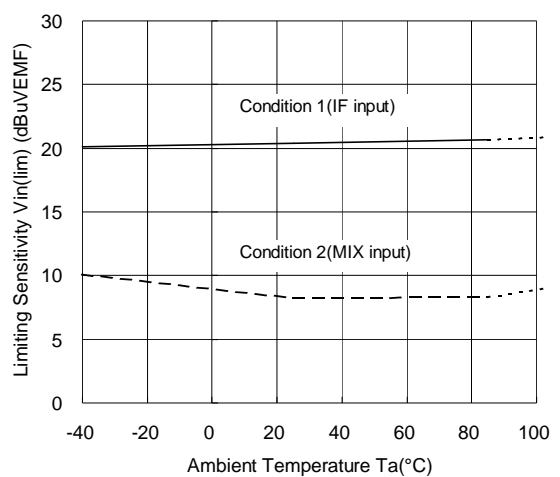

**RSSI Output versus Temperature-Mixer-**

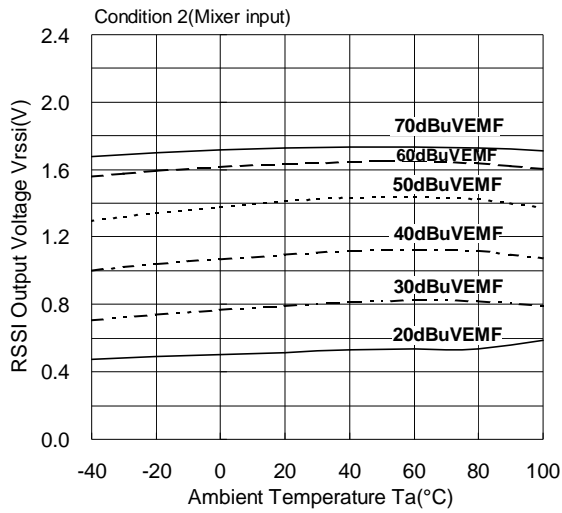

**RSSI Output versus Temperature-IF-**

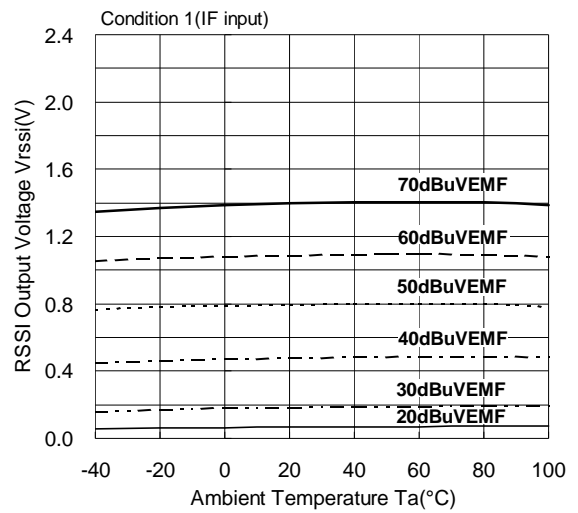

**Quick Charge/Discharge Current versus Temperature**

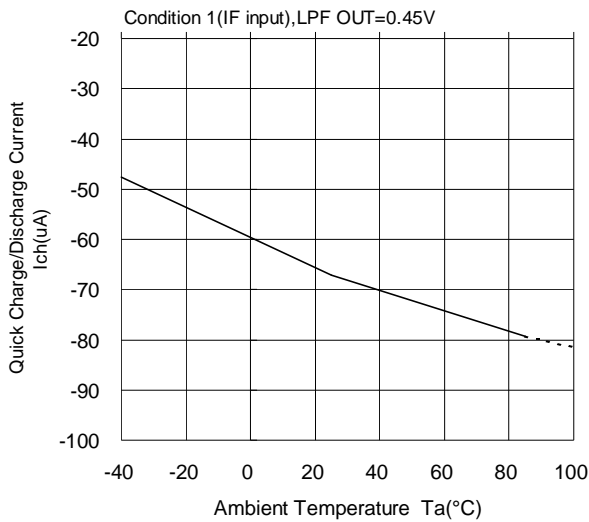

**[CAUTION]**  
 The specifications on this databook are only given for information, without any guarantee as regards either mistakes or omissions. The application circuits in this databook are described only to show representative usages of the product and not intended for the guarantee or permission of any right including the industrial rights.